

CATALOGUE



Biggest range of shopfitting accessories available in South Africa



Till stands



Till Gates



Wrap around Gondola



Shopfitting centre display unit



Bulk wire displays



Index

Merchandising examples & Systems	3
Display Fittings & Accessories	11
Gondola Shelving	27
Library Shelving	35
Wire Mesh Shelving	37
Display Stands	39
Card Holders & Slatwall	43
Turnstilles	45
Industrial Shelving	46
Industrial Racking	48
Gondola Installation Guide.....	53
Pictures	55

Merchandising Examples



Merchandising Examples



Merchandising Profile Examples

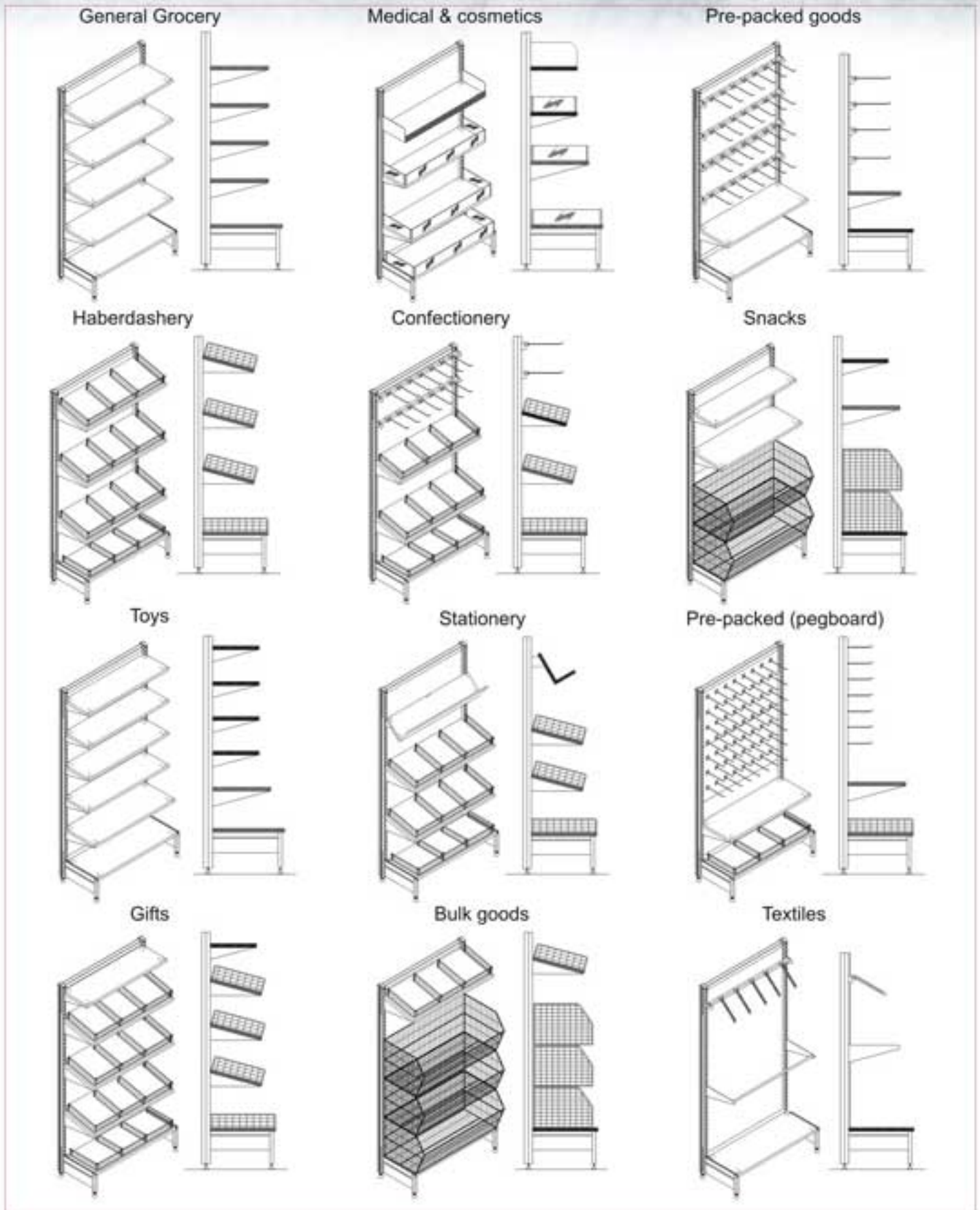

Assembly and Ordering Method

Basic structure of 914mm Gondola Shelving

SS – SINGLE SIDED
DS – DOUBLE SIDED
A – ADD ON

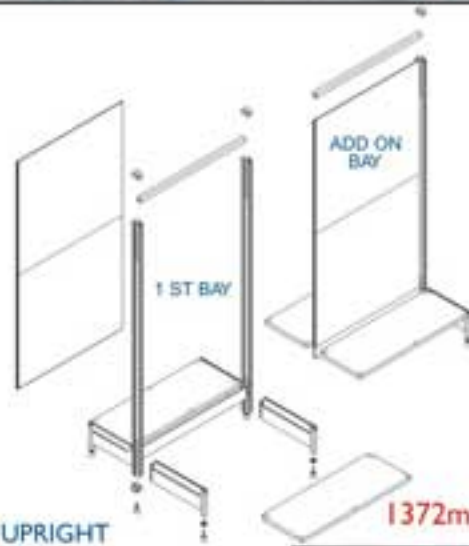

Ordering Method
Stipulate the number of 1st bays and add-on bays needed, using the codes given below. Then indicate the number of each profile needed, referring to the codes given on the opposite page.

1220mm SERIES 60 UPRIGHT

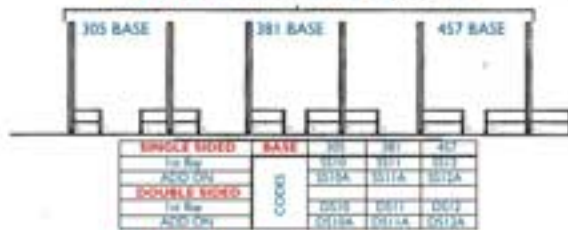

1372mm SERIES 60 UPRIGHT

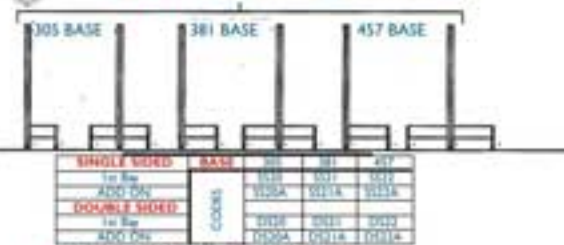

1524mm SERIES 60 UPRIGHT

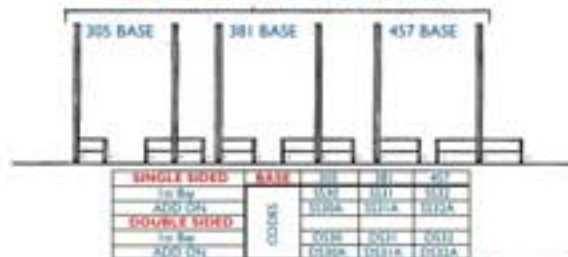

1830mm SERIES 80 UPRIGHT



1830mm SERIES 60 UPRIGHT



2134mm UPRIGHT

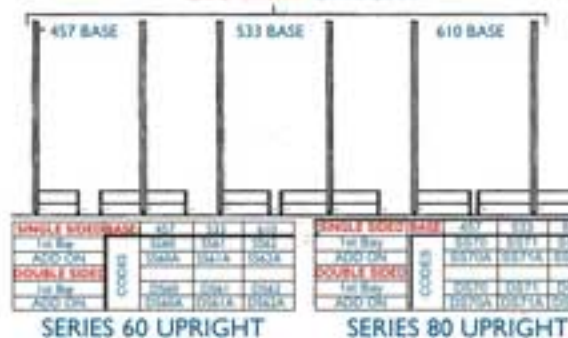

2438mm UPRIGHT

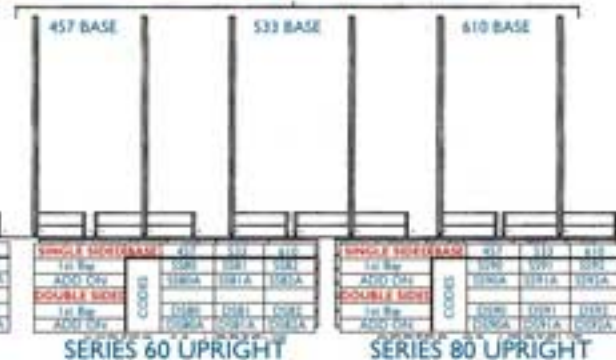

SERIES 60 UPRIGHT

SERIES 80 UPRIGHT

SERIES 60 UPRIGHT

SERIES 80 UPRIGHT

Assembly and Ordering Method

Gondola Profiles

THE CODES REFER TO THE PROFILE COMPONENTS ONLY; ie EXCLUDING UPRIGHTS, INFILL PANELS, BASE FEET & BASE SHELF

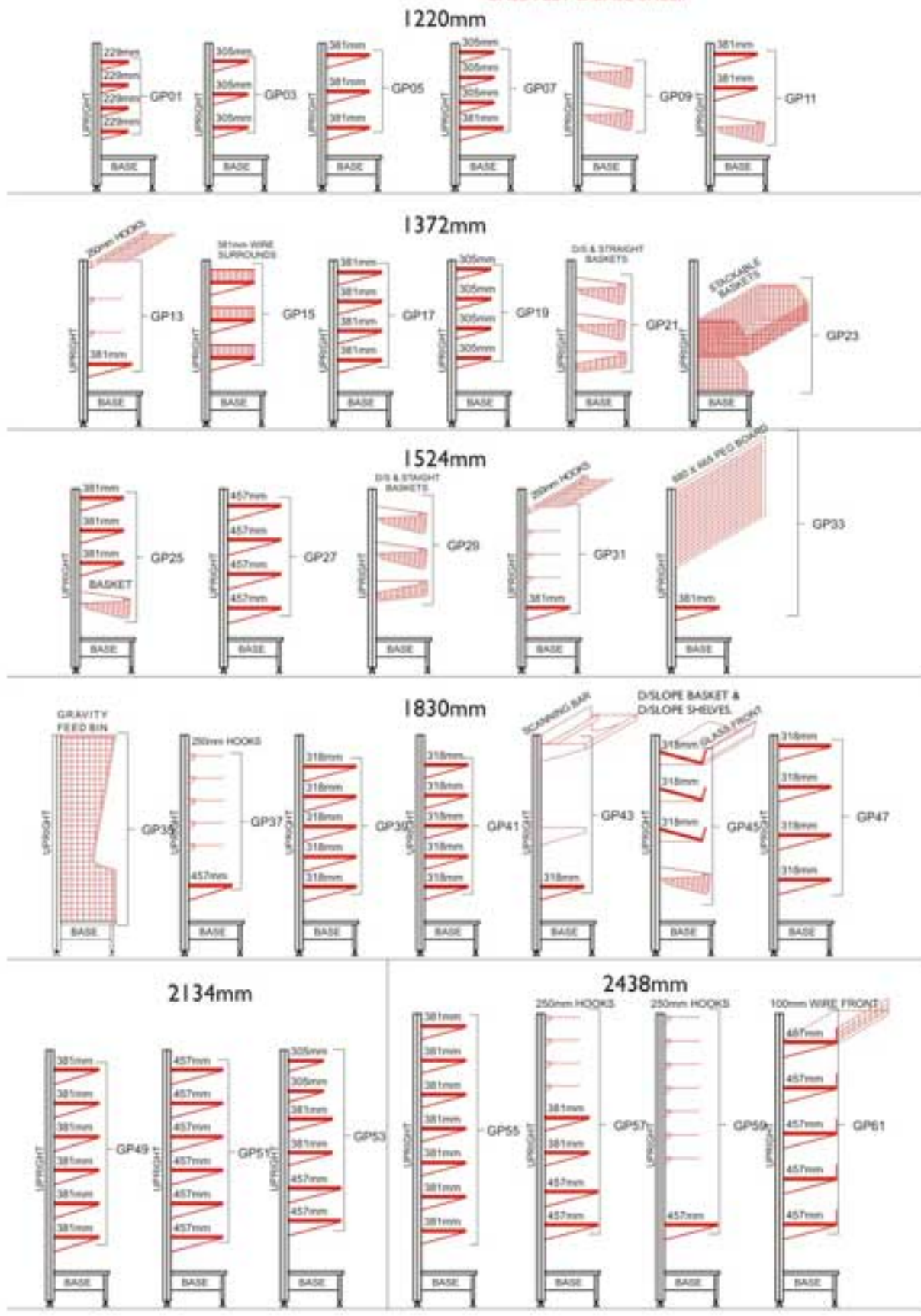

Gondola Systems

K.K. Engineering manufactures 8 gondola systems of which only the 914mm Gondola system is detailed in this catalogue:

Light Duty: 914 mm System



Series 60 (31,75mm Pitch)



Series 80 (31,75mm Pitch)

The series 60 gondola system is suitable for cafes, pharmacies, convenience stores and small supermarkets. The series 80 gondola system features a stronger upright and is thus suitable for small, medium and large stores. Both systems are totally boltless, featuring a steel clip in base foot. These systems may utilise timber infill panels.

Medium Duty: 1m System



Series 100 (31,75mm Pitch)



Series 90 (35mm Pitch)

The series 90 is suitable for medium to large supermarkets, and features a base foot which is welded on to the upright. The series 90 upright is therefore a stronger upright, which utilises steel slide in infill panels.

Gondola Systems

Medium Duty: 1220mm System

Rear support



Series 2000 (50mm Pitch)

The series 2000 is a more elaborate system which features a double clip in-infill panel and a welded basefoot.

divider



Series 70 (50mm Pitch)

The series 70 system is manufactured in a 914mm or 1220mm length, and is suitable for medium to large supermarkets.

riser

*Refer to page 54
Plastic
ticket edge

1220mm System



Series 90H (35mm Pitch)

These systems are most suitable for larger super and Hyper-stores, cash and carry stores and are often used for in-rack Gondolas.

1330mm System



Series 120 (50,8mm Pitch)

*Refer to page 50 to page 53 for examples of stores utilising the relevant Gondola or In-Rack Gondola System.



Display Fixtures and Accessories

CLAMPS

PARALLEL WIRE CLAMP

TO FIT 8mm WIRE

Finish: Bright Galvanised

Code: A015



PARALLEL TUBE CLAMP

TO FIT 25.4mm ROUND TUBE

Finish: Bright Galvanised

Code: A017



CEILING CLIPS

Finish: Bright Galvanised

Code: A019



Card and Label Holders

STEEL CARD HOLDERS

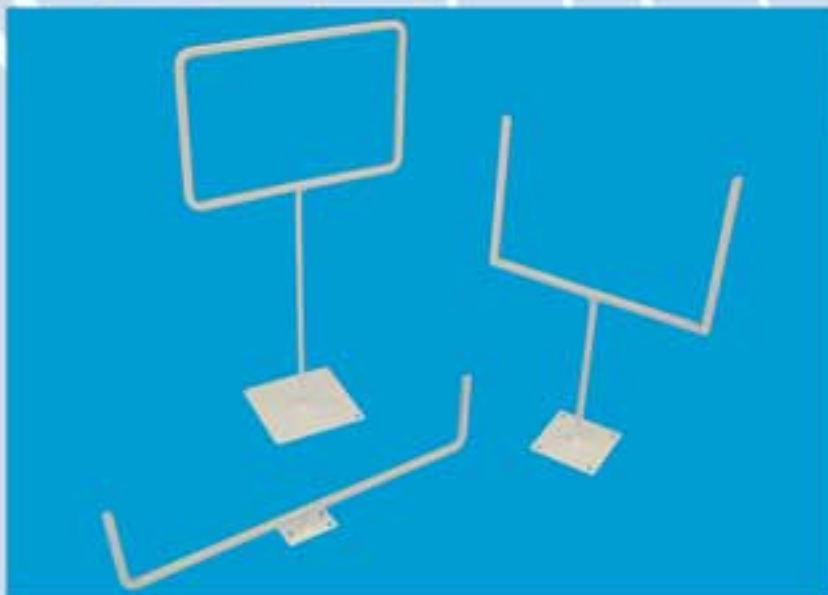

Display Fixtures and Accessories

HANGERS

TROUSER HANGER

WITH RIBBED PLASTIC TUBE

To fit perforated rail

Finish: Chrome or Bright Galvanised

Code: **A020**



SKIRT AND SHIRT HANGER

WITH TWO CLIPS, FOR PERFORATED RAIL

Finish: Chrome or Bright Galvanised

Clips: Black Plastic

Code: **A023** 380mm



SKIRT AND SHIRT HANGER

WITH TWO CLIPS, FOR HANGRAIL

Finish: Chrome or Bright Galvanised

Clips: Black Plastic

Code: **A024** 375mm

A031 250mm



COAT HANGER

FOR - SHIRTS, VESTS, JERSEYS ETC.

5mm Wire

Finish: Chrome or Bright Galvanised

Code: **A040** 230mm

A041 400mm



S-HOOK

Finish: Bright Galvanised

Code: **A050**

VARIOUS OTHER WIRE PRODUCTS AVAILABLE SUBJECT TO
MINIMUM ORDER QUANTITIES



Display Fixtures and Accessories

SPLICERS

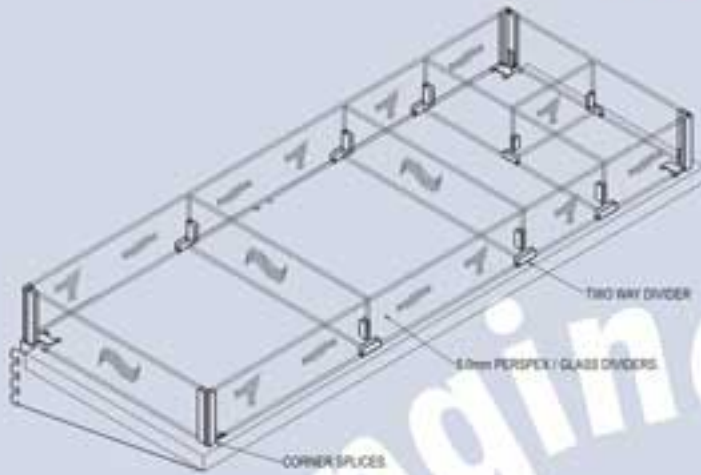

SPLICERS FOR STEEL SHELVES

CORNER SPLICER

Code:	B016	100mm
	B017	75mm
	B018	50mm

Left Hand Side



CORNER SPLICER

Code:	B019	100mm
	B020	75mm
	B021	50mm

Right Hand Side

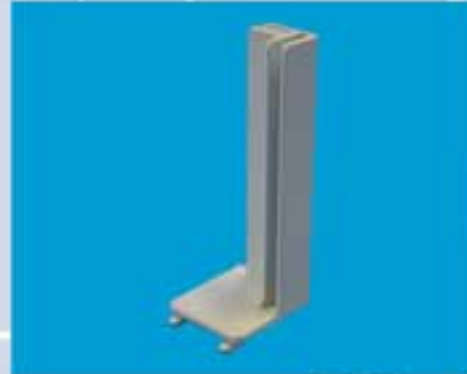

TWO-WAY DIVIDER

Code: **B030**



CENTRE GLASS SUPPORT

Code: **B036**

To support middle of glass front, for downsloping or straight applications



Display Fixtures and Accessories

THE CLASSIC GLASS DISPLAY SYSTEM

A versatile and interchangeable free standing glass display system that has various applications.



TWO WAY CONNECTOR



Code: **B040** 300=2.5kg

FOUR WAY CONNECTOR



Code: **B042** 300=4kg's

THREE WAY CONNECTOR



Code: **B041** 300=3kg's

Use your creative imagination and plan your own unit to suit your needs.
5mm glass must be used with connectors

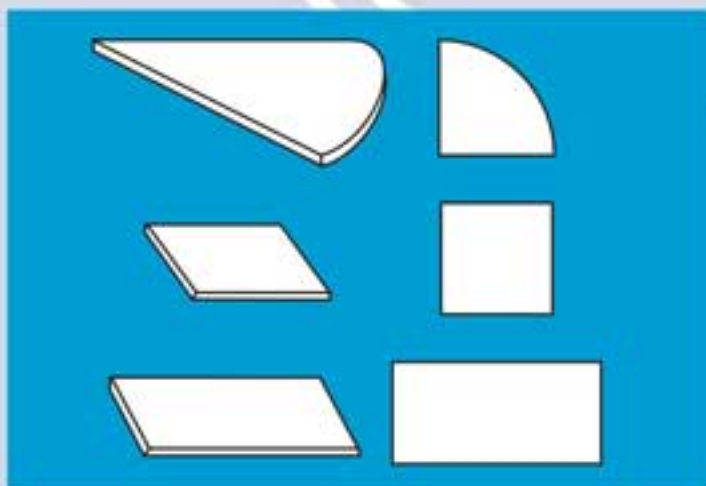

GLASS FOR DISPLAY UNITS FOR 5mm CONNECTORS

QUARTER ROUND 406 x 406

SQUARES 406 x 406

RECTANGLES 833 x 406

PEGBOARD HOOKS

PEGBOARD HOOK

FOR MASONITE PEGBOARD

4.5mm WIRE

Finish: Bright Galvanised

Code:	C010	50mm
	C011	100mm
	C012	150mm
	C013	200mm



PEGBOARD WIRE BUTTON HOOK

FOR MASONITE OR STEEL PEGBOARDS

Finish: Bright Galvanised and white

Code:	C016	100mm
	C017	150mm
	C018	200mm
	C019	250mm



PEGBOARD BUTTON HOOK

FOR MASONITE PEGBOARDS

4mm WIRE

Finish: Bright Galvanised

Code:	C021	100mm
	C022	150mm
	C023	200mm
	C024	250mm



PEGBOARD WIRE HOOK - Medium Duty

FOR MASONITE & STEEL PEGBOARDS

5mm WIRE

Finish: Bright Galvanised

Code:	C030	150mm
	C031	200mm



PEGBOARD WIRE HOOK - Heavy Duty

FOR MASONITE & STEEL PEGBOARDS

6mm WIRE

Finish: Bright Galvanised

Code:	C040	250mm
	C041	300mm



PEGBOARD TRACKING HOOK

FOR STEEL PEGBOARDS with plastic back

Finish: Bright Galvanised

Code: **C042** 150mm

Code: **C043** 225mm

FOR MASONITE PEGBOARDS

Code: **C044** 225mm



REFER TO C060 and C061 FOR PLASTIC HOLDERS SOLD AS A SET WITH TRACKING HOOK



Display Fixtures and Accessories

PEGBOARD HOOKS

PEGBOARD HOOK

FOR STEEL PEGBOARDS

4.5mm WIRE

Finish: Bright Galvanised

Code:	C045	75mm
	C046	125mm
	C047	175mm
	C048	225mm



PEGBOARD BUTTON HOOK

FOR STEEL PEGBOARDS

4.0mm WIRE

Finish: Bright Galvanised

Code:	C052	100mm
	C053	150mm
	C054	200mm
	C055	250mm



MERCHANDISE STOPPER FOR BUTTON HOOK

PREVENTS REMOVAL OF MULTIPLE ITEMS AT ONCE

Finish: Black plastic

Code: **C056**



BUTTON HOOK TICKET FLAP

Finish: Bright Galvanised

Code: **C057** Clip on Ticket Flap



PLASTIC LABEL HOLDER - Clip On

FOR HOOKS OR BASKETS

TO CLIP ONTO WIRE TRACKING HOOK

Finish: Plastic

Code:	C060	30mm x 65mm
	C061	30mm x 90mm

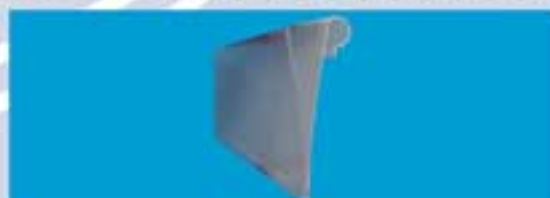

SLATWALL HOOKS

SLAT WALL HOOKS - LONG LIP

5mm WIRE

Finish: Bright Galvanised, Chrome or White

Code:	C070	100mm
	C071	150mm
	C072	200mm
	C073	250mm

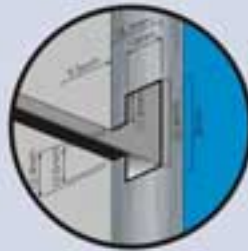

SLAT WALL HOOK - SHORT LIP

5mm WIRE

Finish: Bright Galvanised, Chrome or White

Code:	C075	100mm
	C076	150mm
	C077	200mm
	C078	250mm



SLAT WALL BUTTON HOOK - LONG LIP

Finish: Bright Galvanised, Chrome or White

Code:	C081	100mm
	C082	150mm
	C083	200mm
	C084	250mm

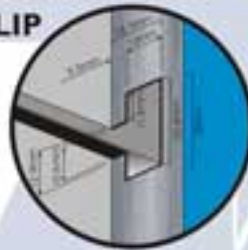

SLAT WALL BUTTON HOOK - SHORT LIP

Finish: Bright Galvanised or Chrome

Code:	C086	100mm
	C087	150mm
	C088	200mm
	C089	250mm



WIRE MESH HOOKS

WIRE MESH HOOK

FOR 50mm MESH

5mm WIRE

Finish: Bright Galvanised or white

Code:	C090	100mm
	C091	150mm
	C092	200mm
	C093	250mm



TO FIT 50mm WIRE MESH

FOR 100mm MESH

6mm WIRE

Finish: Bright Galvanised or white

Code:	C095	100mm
	C096	150mm
	C097	200mm
	C098	250mm



TO FIT 100mm WIRE MESH

Display Fixtures and Accessories

WIRE MESH BUTTON HOOK

TO FIT 50mm MESH

4.5mm WIRE

Finish: Bright Galvanised or white

Code:	C100	100mm
	C101	150mm
	C102	200mm
	C103	250mm



TO FIT 50mm MESH

Finish: Bright Galvanised or white

Code:	C104	100mm
	C106	150mm
	C107	200mm
	C108	250mm



WIRE MESH STEEL HOOK

TO FIT 50mm MESH

Finish: Bright Galvanised

Code:	C110	150mm
	C111	200mm



FLAT BAR HOOKS

FLAT BAR HOOK - LIGHT DUTY

FOR 5 mm FLAT BAR

4.5mm WIRE

Finish: Bright Galvanised

Code:	D010	100mm
	D011	125mm
	D012	150mm



FLAT BAR HOOK - MEDIUM DUTY

FOR 5mm FLAT BAR

6mm WIRE

Finish: Bright Galvanised

Code:	D017	250mm
	D018	300mm



Display Fixtures and Accessories

SQUARE BAR HOOKS

SQUARE BAR HOOK - LIGHT DUTY

FOR 25.4mm SQUARE TUBING

4.5mm WIRE

Finish: Bright Galvanised

Code: **D019** 100mm

D021 150mm

D023 200mm



SQUARE WIRE BAR HOOK - MEDIUM DUTY

FOR 25.4mm SQUARE TUBING

6mm WIRE

Finish: Bright Galvanised

Code: **D030** 200mm

D031 250mm

D032 300mm



SQUARE BAR HOOK - MEDIUM DUTY

FOR 25.4mm SQUARE TUBING

6mm WIRE

Finish: Bright Galvanised

Code: **D033** 200mm

D034 225mm

D035 250mm

D036 300mm

Hooks also available to fit 12.5mm and 19mm tubing.



PLASTIC HOOK SPACER - MERCHANDISE STOPPER

FOR 8mm WIRE

Finish: Light grey plastic

Code: **D039**



SQUARE BAR HOOK - HEAVY DUTY

FOR 25.4mm SQUARE TUBING

8mm WIRE

Finish: Bright Galvanised

Code: **D040** 300mm

D041 350mm

D042 400mm

D043 450mm

Hooks also available to fit 12.5mm and 19mm tubing.



SQUARE BAR WIRE HOOK - HEAVY DUTY

FOR 25.4mm SQUARE TUBING

8mm WIRE

Finish: Bright Galvanised

Code: **D044** 300mm

D045 350mm

D046 400mm

D047 450mm



Display Fixtures and Accessories



DOUBLE HOOK - HEAVY DUTY

FOR 25.4mm SQUARE TUBING

8mm WIRE

Finish: Bright Galvanised

Code: **D048** 370mm (50mm x 300mm)

D050 500mm (50mm x 400mm)



DOUBLE SPADE HOOK - HEAVY DUTY

FOR 50 AND 25mm RECTANGULAR TUBING

8mm WIRE

Finish: Bright Galvanised

Code: **D051** 370mm

D052 500mm

D053 600mm



TRACKING HOOK

FOR 25.4mm SQUARE TUBING

8mm WIRE

Finish: Bright Galvanised

Code: **D060** 200mm (Medium Duty - 6mm Wire)

D061 300mm (Medium Duty - 6mm Wire)

D062 300mm (Heavy Duty - 8mm Wire)

D063 400mm (Heavy Duty - 8mm Wire)

Refer code C064 for label holder only.



P.I. LABEL HOLDER

TO FIT OVER SQUARE BAR HOOK BRACKET

Code: **D065** 200mm

D066 250mm

D067 300mm



SQUARE BAR TRACKING HOOK

TO FIT OVER SQUARE BAR HOOK BRACKET

Code: **D075** 200mm

D076 250mm

D077 300mm

Refer code C060 for plastic label holder.



CLIP ON SQUARE BAR BUTTON HOOK - HEAVY DUTY (PATENTED)

TO FIT 25.4mm SQUARE TUBING OR 50 & 25mm SQUARE TUBING

Code: **D080** 200mm

D081 300mm



Also available to fit 19mm tubing

Display Fixtures and Accessories

RECTANGULAR BAR HOOKS

RECTANGULAR BAR HOOK - MEDIUM DUTY

FOR 12.7mm x 25.4mm TUBING.

6mm wire.

Finish: Bright Galvanised

Code: **D090** 300mm

D091 350mm



RECTANGULAR BAR HOOK - HEAVY DUTY

FOR 12.7mm x 25.4mm TUBING.

8mm wire.

Finish: Bright Galvanised

Code: **D100** 300mm

D101 400mm



P.I. LABEL HOLDER

TO FIT OVER RECTANGULAR BAR HOOK

Finish: Bright Galvanised

Code: **D110** 320mm

D111 370mm



Code: **D115** 320mm

D116 370mm



PLASTIC LABEL HOLDER - Clip On

FOR HOOKS OR BASKETS

TO CLIP ONTO WIRE TRACKING HOOK

Finish: Bright Galvanised

Code: **C060** 30mm x 65mm

C061 30mm x 90mm

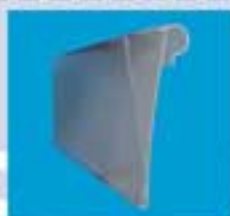

ASSEMBLED RECTANGULAR BAR HOOK WITH P.I. LABEL HOLDER



Display Fixtures and Accessories

DISPLAY BARS

FLAT BAR

25mm x 5mm

Finish: Bright Galvanised

Code: **E010** 25mm x 5mm x 914mm

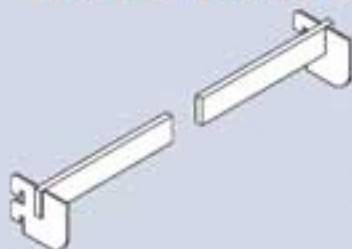

FLAT BAR BRACKET

With 5mm slot

Finish: Bright Galvanised

Code: **E020** 40mm

E021 140mm

Only sold as set with flat bar



PERFORATED SQUARE BAR

25.4mm x 25.4mm with 6.5mm hole diameter

Finish: Bright Galvanised/Chrome

Code: **E030** 902mm (36 holes, 914mm unit)

E032 1203mm (48 holes, 1219mm unit)



RECTANGULAR BAR

12.7mm x 25.4mm

Finish: Bright Galvanised/Chrome

Code: **E035** 902mm (914mm unit)

E036 1203mm (1219mm unit)



RECTANGULAR BAR BRACKET

Code: **E037** 40mm

E038 100mm

Only sold as set with rectangular bar

SQUARE BAR

25.4mm x 25.4mm

Finish: Bright Galvanised/Chrome

Code: **E040** 902mm (914mm unit)

E042 1203mm (1219mm unit)

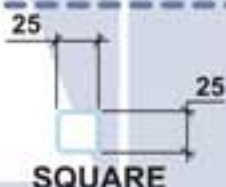

SQUARE



ROUND HANGING RAIL

25.4mm Diameter round tubing

Finish: Bright Galvanised/Chrome

Code: **E043** 912mm (914mm unit)

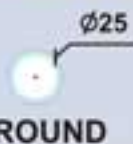

ROUND



OVAL HANGING RAIL

Finish: Chrome Plated

Code: **E046** 18mm x 32mm x 1.6mm x 912mm (914mm unit)

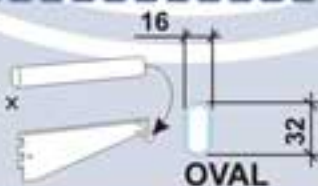

OVAL



RUBBER GROMMET

Code: **E047**



Display Fixtures and Accessories



SPADE HOOK BAR - HEAVY DUTY (914 mm)

50mm + 25mm TUBE WITH WELD ON BRACKETS

Code: **E048** 902mm (for 914mm unit)



SQUARE BAR BRACKET

Only sold as a set with square bar, E040)

WITH INSERT FOR 25.4mm TUBING

Finish: Bright Galvanised

Code: **E050** 40mm (without insert)

E051 100mm (without insert)

E052 140mm (without insert)

E053 Insert for square brackets

Only sold as set with square bar (Code E040)



LAX BRACKET

TO FIT 50mm PITCH, FOR SQUARE BAR

Finish: Bright Galvanised

Code: **E065** 75mm (without insert)

E066 150mm (without insert)

E053 Insert for square bar brackets



SLOTTED BRACKETS

GEESENECK STRAIGHT SLOTTED BRACKET

TO FIT 25.4mm SQUARE TUBING

Finish: Bright Galvanised/Chrome or Powder Coated

Code: **F010** 320mm x 12 slots, standard pitch

F013 420mm x 20 slots, fine pitch



Standard Pitch

GEESENECK DOWN-SLOPING SLOTTED BRACKET

TO FIT 25.4mm SQUARE TUBING

Finish: Bright Galvanised/Chrome or Powder Coated

Code: **F019** 320mm x 12 slots, standard pitch

F022 420mm x 20 slots, fine pitch



Fine Pitch

SLATWALL GEESENECK BRACKET

Finish: Bright Galvanised/Chrome or Powder Coated

Code: **F025** 320mm x 12 slots, standard pitch



Note: All Geese-necks utilize special flat bar material that features rolled rounded edges

Display Fixtures and Accessories

WALLBAND GEESENECK BRACKET DOWN-SLOPING

Finish: Bright Galvanised/Chrome or Powder Coated
Code: F028 350mm x 12 slots, standard pitch
F029 450mm x 20 slots, fine pitch



WIRE MESH GEESENECK BRACKETS

TO FIT 100mm SQUARE MESH

Finish: Bright Galvanised/Chrome or Powder Coated
Code: F030 12 slot with 60mm bracket, standard pitch
F031 20 slot with 60mm bracket, fine pitch

(Wall bracket Geeseneck - on application)



TENNIS RACQUET HOLDER - For six racquets

Finish: Bright Galvanised/Chrome or Powder Coated
Code: F035



FLAT BAR BRACKETS

WIRE MESH FLAT BAR BRACKETS

TO FIT 100mm SQUARE MESH (WITH BALL ON END)

Finish: Bright Galvanised/Chrome or Powder Coated
Code: F040 300mm - with 60mm bracket
F041 300mm - with 60mm bracket



FLAT BAR BRACKET

TO FIT 25.4mm SQUARE BAR

Finish: White or Bright Galvanised
Code: F050 400mm



SLAT WALL FLAT BAR BRACKET

Finish: White or Bright Galvanised
Code: F055 300mm



TUBE INSERTS

NYLON INSERT

WITH 10mm THREAD
TO FIT 25.4mm SQUARE TUBING
Code: **G011**



NYLON INSERT

WITH 12mm THREAD, FOR GONDOLA UPRIGHT
Code: **G014** series 60 upright
G015 series 80 upright
G016 series 100 upright



NYLON TUBE INSERTS ALSO AVAILABLE TO FIT:

38mm x 38mm TUBING
25mm x 50mm TUBING
70mm x 35mm TUBING
90mm x 35mm TUBING

PIPE CLOSURES

VARIOUS SIZES AVAILABLE

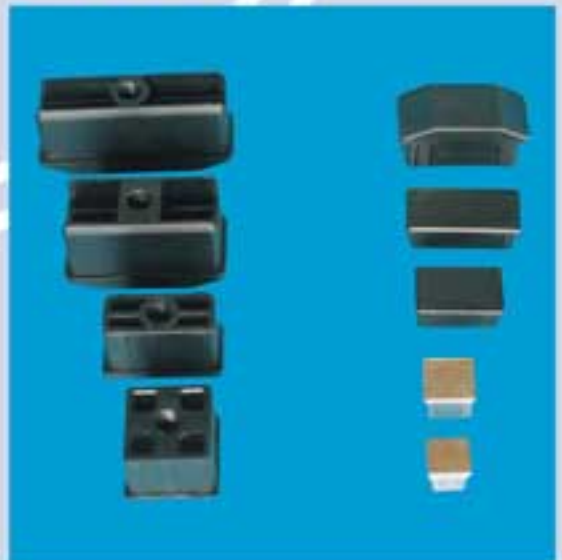

LEVELLING SCREWS

PLASTIC LEVELLING SCREW WITH FIXED BASE

Code: **G020** M10 x 40mm thread
G021 M10 x 25mm thread



STEEL LEVELLING SCREW

SWIVEL BASE WITH 17mm HEXAGON

Finish: Bright Galvanised

Code: **G022** M10 x 50mm thread
G023 M12 x 50mm thread
G024 M12 x 75mm thread
G026 M12 x 100mm thread



NYLON LEVELLING SCREW

FIXED BASE WITH 17mm SQUARE

Finish: Bright Galvanised

Code: **G028** M10 x 60mm thread
G029 M12 x 70mm thread



NYLON LEVELLING SCREW

SWIVEL BASE WITH 17mm HEXAGON

Code: **G035** M12 x 75mm thread



Gondola shelving - 914mm System:

WALL BANDS

WALL BANDS - SINGLE SLOTTED

- Finish: Light Cream, White or Chrome
- Code: **H010** Sizes: 2"= 610mm
H011 Sizes: 3"= 915mm
H012 Sizes: 4"= 1220mm
H013 Sizes: 5"= 1524mm
H014 Sizes: 6"= 1830mm
H015 Sizes: 7"= 2134mm
H016 Sizes: 8"= 2438mm



WALL BANDS - DOUBLE SLOTTED

- Finish: Light Cream, White or Chrome
- Code: **H020** Sizes: 2"= 610mm
H021 Sizes: 3"= 915mm
H022 Sizes: 4"= 1220mm
H023 Sizes: 5"= 1524mm
H024 Sizes: 6"= 1830mm
H025 Sizes: 7"= 2134mm
H026 Sizes: 8"= 2438mm
H027 Sizes: 3000mm



WALL BAND SADDLE

Finish: Light Cream, White or Chrome
Code: H030
 (to support wall band for heavy applications)

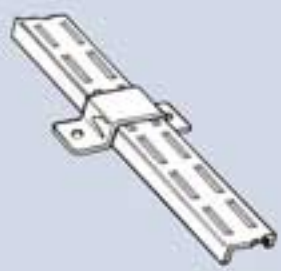

Gondola Shelving - 914 mm System: Series 60, 80 and 100

UPRIGHTS

GONDOLA UPRIGHTS - SERIES 60

Finish: Light Cream or White

Code:	1022	Sizes:	4"	=	1220mm
	1023	Sizes:	4.6"	=	1372mm
	1024	Sizes:	5"	=	1524mm
	1025	Sizes:	6"	=	1830mm

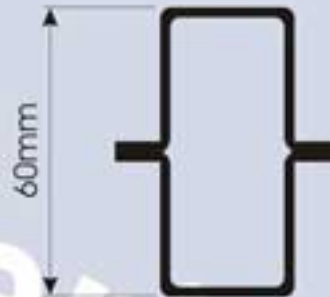

SERIES 60

UPRIGHT TOP CAP

FOR GONDOLA UPRIGHTS

Finish: Light Cream or White

Code:	1030	-	SERIES 60
	1032	-	SERIES 80
	1034	-	SERIES 100



GONDOLA UPRIGHTS - SERIES 80

Finish: Light Cream or White

Code:	1040	Sizes:	6"	=	1830mm
	1041	Sizes:	7"	=	2134mm
	1042	Sizes:	8"	=	2438mm

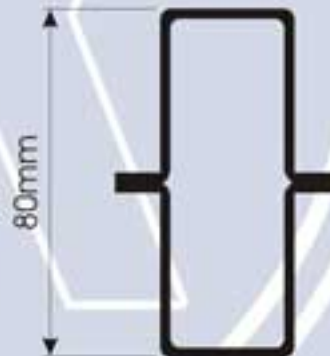

GONDOLA UPRIGHTS - SERIES 100

Finish: Light Cream or White

Code:	1045	Sizes:	=	1970mm
	1046	Sizes:	=	2134mm
	1047	Sizes:	=	2438mm
	1048	Sizes:	=	3000mm

(heavy duty upright)

Also available with weld on basefoot

S-80 INTERNAL BRACE

Code: 1052 Sizes: 1400mm

Inserted in the bottom part of an upright and give additional strength



SERIES 60

SERIES 80

Gondola Shelving

GONDOLA - SERIES 60 and 80



(A)

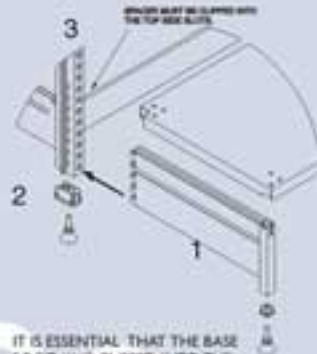

IT IS ESSENTIAL THAT THE BASE FOOT (1) IS CLIPPED INTO THE LOWEST SLOT BEFORE THE NYLON INSERT (2) IS PLUGGED INTO THE UPRIGHT (3)

DETAIL

(A)

GONDOLA BASE FEET

Finish:	Light Cream or White	
Code:	J011	305mm
	J012	381mm
	J013	457mm
	J014	533mm
	J015	610mm

NOTE: When assembling End gondolas, ensure that the welding faces the inside.



WALL BAND BASE FEET

Finish:	Light Cream or White	
Code:	J017	305mm
	J018	381mm
	J019	457mm
	J020	533mm
	J021	610mm

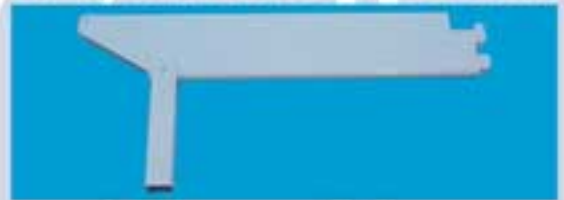

GONDOLA SPACERS

Finish:	Light Cream or White	
Code:	K010	914mm



GONDOLA TOP COVER

Finish:	Light Cream or White	
Code:	K014	914mm



KICK PLATE

Finish:	Light Cream or White	
Code:	K020	914mm Gondola kick plate
	K021	914mm Wall band kick plate



Gondola Shelving

BRACKETS

STRAIGHT SHELF BRACKET

FOR STEEL AND TIMBER SHELVES

Finish: Light Cream and White

Slimline

Code: **L010** 152mm
L011 229mm

Standard

Code: **L012** 305mm
L013 381mm
L014 457mm

Heavy Duty

Code: **L015** 533mm
L016 610mm

With top and bottom bend.



DOWN SLOPING BRACKET

FOR STEEL AND TIMBER SHELVES

Finish: Light Cream and White

Code: **L021** 229mm
L022 305mm
L023 381mm
L024 457mm



PLASTIC RIVET

TO SECURE SHELF ON DOWN SLOPING BRACKET

Code: **L027**



ROUND HANG RAIL BRACKET

FOR 25.4 mm ROUND RAIL (Sold as a set with round bar)

Finish: Light Cream, White or Chrome

Code: **L030** 305mm
L031 381mm



To be fixed to round hanging rail with self tapping screw - not supplied.



Gondola Shelving

OVAL HANG RAIL BRACKET

FOR OVAL RAIL

Finish: Light Cream, White or Chrome

Code: **L040** 305mm
L041 381mm



ADJUSTABLE SHELF BRACKET

FOR STEEL, TIMBER OR GLASS SHELVES

Finish: Light Cream or White

Code: **L050** 229mm
L051 305mm
L052 381mm



GLASS SHELF BRACKET - STRAIGHT

SLIMLINE STRAIGHT WITH FRONT STOPPER

Finish: Light Cream, White or Chrome

Code: **L070** 6" = 152mm
L071 9" = 229mm
L072 12" = 305mm
L073 15" = 381mm



GLASS SHELF BRACKET - DOWN SLOPING

SLIMLINE DOWN-SLOPING WITH FRONT STOPPER (25°)

Finish: Light Cream, White or Chrome

Code: **L082** 12" = 305mm
L083 15" = 381mm



DISPENSARY SHELF BRACKET

Finish: White Epoxy

Code: **L090** 152mm with Radius



Gondola Shelving

SHELVES

GONDOLA SHELVES - 914mm

Finish: Light Cream or Appliance White

Code:	M020	152mm
	M021	229mm
	M022	305mm
	M023	381mm
	M024	457mm
	M025	533mm
	M026	610mm

1m and 1220mm shelves available on application.



GONDOLA WIRE SHELVES - Straight 914mm

Finish: Light Cream, White, Galvanised or Chrome
TO FIT ONTO STANDARD BRACKETS

Code:	M030	381mm
	M031	457mm



GONDOLA WIRE SHELVES - Curved 914mm

Finish: Light Cream, White, Galvanised or Chrome
TO FIT ONTO STANDARD BRACKETS

Code:	M035	381mm
	M036	457mm



DISPENSARY SHELF

Finish: White

Code:	M040	152mm
-------	-------------	-------

(Magazine display shelf made to order)



WIRE FRONTS

Finish: Light Cream or White

Code:	M050	914mm x 100mm
	M051	914mm x 50mm



SHELF FRONT

Finish: Light Cream or White

Code:	M055	914mm x 50mm
-------	-------------	--------------



WIRE SURROUNDS

Finish: Light Cream or White

Code:	M060	914mm x 305mm
	M061	914mm x 381mm
	M062	914mm x 457mm



Gondola Shelving

PLAIN INFILL PANELS

TO FIT 914mm Gondola

FOR SERIES 60 AND SERIES 80 UPRIGHTS

Finish: Light Cream or White

Code:	N009	610mm x 880mm
	N011	1050mm x 880mm
	N012	1210mm x 880mm
	N013	1370mm x 880mm



PERFORATED INFILL PANELS

TO FIT 914mm Gondola

FOR SERIES 60 AND SERIES 80 UPRIGHTS

Finish: Light Cream or White

Code:	N019	610mm x 880mm
	N020	830mm x 880mm
	N021	1050mm x 880mm
	N022	1210mm x 880mm
	N023	1370mm x 880mm

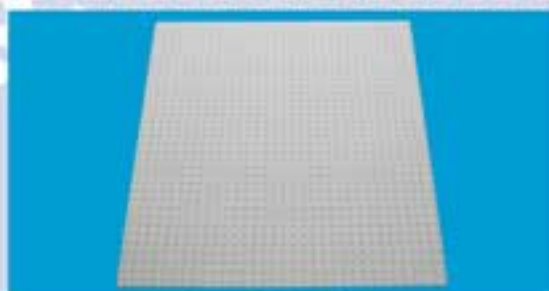

COMBINATION OF SIZES REQUIRED

1220mm Upright - Top cover
 1372mm Upright - Top cover
 1524mm Upright - Top cover
 1830mm Upright - Top cover
 2134mm Upright - Top cover
 2438mm Upright - Top cover

PLAIN

(1 x 1050mm)
 (1 x 1210mm)
 (1 x 1370mm)
 (1050mm x 610mm)
 (1050mm x 930mm)
 (1210mm x 1050mm)

PERFORATED

(1 x 1050mm)
 (1 x 1210mm)
 (1 x 1370mm)
 (2 x 830mm)
 (1050mm x 930mm)
 (1210mm x 1050mm)

PERFORATED CLIP IN PANELS

TO FIT 914mm Gondola

TO CLIP INTO UPRIGHT

Finish: Light Cream or White

Code:	N030	505mm x 880mm
	N031	665mm x 880mm



PERFORATED SHEET

RAW

Code:	N050	2450mm x 1225mm x 1.2mm
	N051	2450mm x 1225mm x 1mm

Hole Ø - 5.5mm

Hole pitch - 25.4mm



Pegboard panels and stands also made to order

Gondola Shelving



WIRE BASKETS

DOWN SLOPING BASKET

Finish: Ivory or White

- Code: O010** 910mm x 380mm Basket
Set includes:- **O012** Basket bracket 380mm - Left
O013 Basket bracket 380mm - Right
O014 Wire Basket Tray 380mm x 910mm



- Code: O015** 910mm x 460mm Basket
Set includes:- **O017** Basket bracket 460mm - Left
O018 Basket bracket 460mm - Right
O019 Wire Basket Tray 460mm x 910mm

STRAIGHT BASKET

Finish: Ivory or White

- Code: O020** 910mm x 380mm Basket
Set includes:- **O014** Wire Basket Tray 380mm x 910mm
O021 Basket bracket 380mm - Left
O022 Basket bracket 380mm - Right



- Code: O025** 910mm x 460mm Basket
Set includes:- **O019** Wire Basket Tray 460mm x 910mm
O026 Basket bracket 460mm - Left
O027 Basket bracket 460mm - Right



DIVIDER BIN - Straight

Finish: White

- Code: O045** 910mm x 380mm



DIVIDER BIN - Down-sloping

Finish: White

- Code: O046** 910mm x 380mm



BIN DIVIDERS

FITS BOTH STRAIGHT AND DOWN-SLOPING BIN

Finish: White

- Code: O047**



Library Shelving

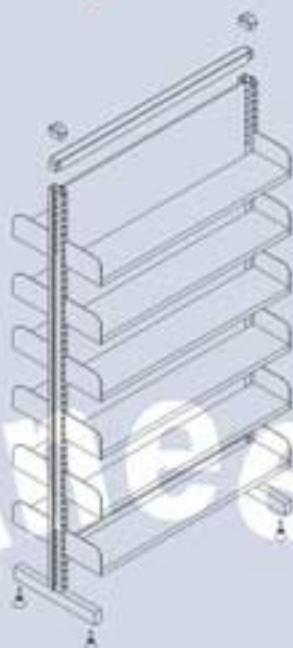

Oak or Imbuia end panels available on request.

The KK Library system consists of 914mm modular units. The system is entirely boltless which allows for fast and simple installation. Various accessories are available including Imbuia or Oak end panels end panels to enhance the final appearance. The standard finish is epoxy light cream.

LIBRARY UPRIGHTS

DOUBLE SIDED

Code:	R008	1220mm x 270mm
	R009	1524mm x 270mm
	R010	1830mm x 270mm
	R011	2134mm x 270mm



SINGLE SIDED

Code:	R013	1220mm x 270mm
	R014	1524mm x 270mm
	R015	1830mm x 270mm
	R016	2134mm x 270mm



SPACERS - 914mm

Code: **K010**



BOOK BACK STOP - 914mm

Code: **R025**



TOP COVER - 914mm

Code: **K014**



LIBRARY BRACKETS

Code:	R032	270mm Left Hand
	R033	270mm Right Hand



Library Shelving

STANDARD SHELF

Code: R041 270mm x 905mm



SHELF WITH BACK LIP TURNED UP

Code: R043 270mm x 905mm



PERIODICAL DISPLAY SHELF

Code: R045 305mm x 905mm



BOOK SHELF WITH WELD-ON BRACKETS

Code: R047 305mm x 150mm x 914mm

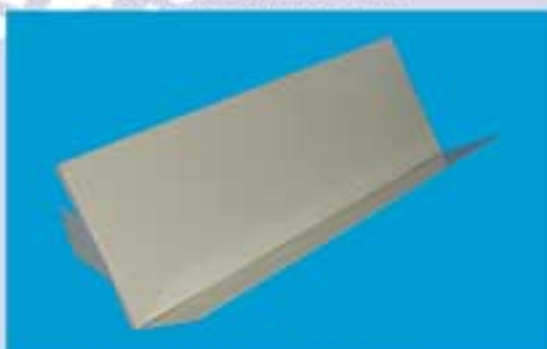

LIBRARY ACCESSORIES

INDEX DIVIDER

Finish: Ivory
Code: R050

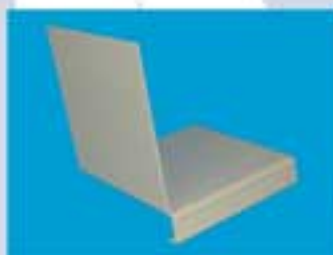

L-SHAPED BOOK SUPPORT

Finish: Ivory
Code: R051



LABEL HOLDER

Finish: Ivory
Code: R055

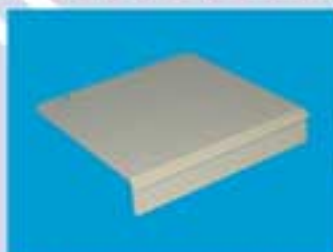

RANGE INDICATOR

Finish: Ivory
Code: R056



WIRE BOOK SUPPORT

Finish: Ivory or Chrome
Code: R063 270mm Chrome
R064 270mm P/Coated



Wire Mesh Shelving

CLOTHING UNIT



Various units and sizes available (Refer detailed brochure)



DOWN SLOPING SHELVES

1600mm x 1500mm

36



COMBINATION DISPLAY UNITS



RECTANGULAR SHELF UNIT

1800mm x 900mm x 450mm

Wire Mesh Shelving



MAGAZINE & NEWSPAPER UNITS
1500mm x 400mm x 900mm x 350mm



CURVED FRONT SHELVES
1800mm x 900mm x 550mm



END GONDOLA WITH CURVED SHELVES
1800mm x 900mm x 550mm



DOWN SLOPING SHELVES DEEP ANGLE
1800mm x 1700mm x 350mm



TILL POINT IMPULSE UNITS (Top shelf and three down sloping shelves)
1200mm x 900mm x 600mm



CENTRE GONDOLA CAKE STAND
1200mm x 900mm x 600mm



CENTRE GONDOLA WITH DOWN SLOPING SHELF MAGAZINE STAND
1200mm x 900mm x 600mm

Display Stands for Clothing

All stands are fully collapsable to facilitate transport & storage.

DRESS RAIL

CHROME RAIL, WHITE BASE

Code: S020	1.25mm x 1.25mm			
	set includes:	S023	Chrome Rail	1 Required
		S024	Base	1 Required
		S025	Uprights	2 Required
S021	1.45mm x 1.45mm			
	set includes:	S026	Chrome Rail	1 Required
		S027	Base	1 Required
		S028	Uprights	2 Required
S022	1.65mm x 1.65mm			
	set includes:	S029	Chrome Rail	1 Required
		S036	Base	1 Required
		S041	Uprights	2 Required



FOUR ARM STANDS for Clothing Retail Outlets (with patented adjustment mechanism)

OVAL TUBE FOUR ARM STAND

Finish: Powder coated base with polished chrome top

- Code: S037** Straight arms
S038 Stepped arms
S039 2 Stepped and 2 Straight arms

patented locking mechanism



FOUR ARM STAND WITH STRAIGHT ARMS

25.4mm SQUARE TUBING BASE - TOTALLY DEMOUNTABLE

Finish: White base with polished chrome top

Code: S040

patented locking mechanism



FOUR ARM STAND WITH GEESENECK ARMS

25.4mm SQUARE TUBING BASE - TOTALLY DEMOUNTABLE

Finish: White base with polished chrome top

Code: S042



FOUR ARM STAND WITH STEPPED ARMS

25.4mm SQUARE TUBING BASE - TOTALLY DEMOUNTABLE

Finish: White base with polished chrome top

- Code: S040** FOUR ARM STANDS with straight chrome arms
S042 FOUR ARM STANDS with geeseneck chrome arms
S044 FOUR ARM STANDS with stepped chrome arms.

BASE COMPONENTS (Only sold as a complete set)

S045	Base	1 Required
S046	Uprights	1 Required
S047	Top with 8 screws	1 Required

- S049** Tube Lock
S048 Base arms - straight, screw on, adjustable (to convert stand to 8 way stand)
S050 Straight arms - Polished Chrome
S051 Geeseneck arms - Polished Chrome
S052 Stepped arms - Polished Chrome
S054 Tube lock



Display Stands

for Clothing Retail Outlets

BASE ARMS

SCREW ON, TO CONVERT STAND TO 8 WAY STAND

Finish: Polished Chrome

Code: S048 400mm



Straight arms

Finish: Polished Chrome

Code: S050



Geeseneck arms

Finish: Polished Chrome

Code: S051



Stepped arms

Finish: Polished Chrome

Code: S052



8 WAY MERCHANDISER

Code: S055 Polished Chrome Base and Straight Arms (8 Arms)

S056 Powder Coated Base and Straight Chrome Arms (8 Arms)



TWO WAY GEESENECK STAND

Finish: White Epoxy with Chromed Top

Code: S060



DOUBLE TWO WAY GEESENECK STAND

Finish: White Epoxy with Chromed Top

Code: S062



SPIRAL STAND

Finish: White Epoxy with Chromed 2m Spiral

Code: S065

Chrome Spiral

set includes: S063 1 x Chrome geeseneck spiral
S064 1 x Base
S066 1 x Top + 4 x bolts



Display Stands

TILL STAND

COMPLETE WITH SHELVES, HOOKS, BASKETS AND LEVELLERS

Code: **S067** 600mm x 600mm
S068 914mm x 600mm



PEGBOARD STAND

1000mm x 1830mm

Code: **S070**



WIRE MESH DISPLAY STANDS

DUMP BIN HEAVY DUTY

WITH ADJUSTABLE BASE SHELF

1200mm x 800mm x 900mm

Code: **S072**



HEAVY DUTY STACKING BASKETS

910mm x 450mm x 300mm

Code: **S074**



LIGHT DUTY STACKING BASKETS

square 500mm x 500mm x 900mm with shelf

Code: **S076**



Display Stands

GRAVITY FEED BIN

Finish: Ivory or White

Code: **O035** 1750mm x 900mm x 600mm

Loose panels to be clamped together with 8mm wire clamps (optional)



SELF STACKING BASKET - Light Duty

Finish: Ivory or White

Code: **O040** 620mm x 500mm x 300mm

Code: **O041** 870mm x 500mm x 400mm



WIRE GRIDS WITH FRAME

2000mm x 1000mm with 25.4mm round tube frame

Code: **S080**



MULTI PURPOSE WIRE MESH STAND

2000mm x 1000mm with 25.4mm round tube frame

Code: **S088**



WIRE SHOE RACK

TO CLIP ONTO 50mm² WIRE GRID

Finish: Light Cream or White

Code: **S102** 300mm



WIRE SHOE HOOK

SLATWALL

Finish: Chrome or Epoxy

Code: **S105**



WIRE SHOE HOOK

PEGBOARD

Finish: Chrome or Epoxy

Code: **S106**



Card and Label Holders

SHELF EDGE LABEL HOLDERS

STICK ON LABEL HOLDER

CLEAR PLASTIC FRONT WITH VARIOUS COLOURED BACKGROUNDS

Code:	T020	914mm
	T021	1000mm
	T022	1220mm
	T023	1330mm



VERTICAL CLIP-ON LABEL HOLDER

CLEAR PLASTIC

Code:	T030	914mm
	T031	1000mm
	T032	1220mm
	T033	1330mm



45° CLIP ON SHELF EDGE

CLEAR PLASTIC

Code:	T053	914mm
	T054	1000mm
	T055	1220mm
	T056	1330mm



SCANNING BAR

Code:	T060	914mm for 25.4mm square bar
-------	-------------	-----------------------------



TRACKING UTILITY BAR

Code:	T070	25.4mm Sqr tube - 381mm Angled
	T071	25.4mm Sqr tube - 381mm Perpendicular
	T079	25.4mm Sqr tube - 457mm Angled
	T080	25.4mm Sqr tube - 457mm Perpendicular



Back Square Bar

Front Channel

Utility Bar Bracket

Aluminium Products

SLATWALL COMPONENTS

SLATWALL PANEL

Code:



SLATWALL STAND

Code:



SLATWALL EXTRUSION FOR TIMBER PANELS

SMALL EXTRUSION

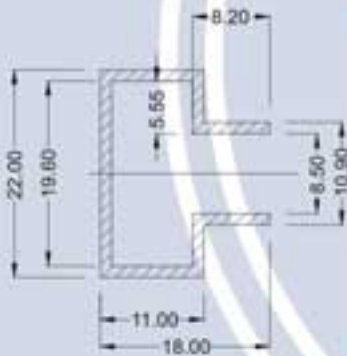

LARGE EXTRUSION

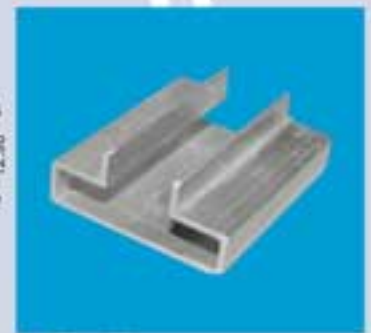

DISPLAY CABINET COMPONENTS

ALUMINIUM BRACKET

Code:

- 180mm
- 250mm
- 280mm
- 350mm



ALUMINIUM WALLBAND EXTRUSION

Code:

457mm - 610mm



Turnstiles and Barrier Railing



MECHANICAL ENTRY GATE

Code: **V010** Left Hand
V011 Right Hand

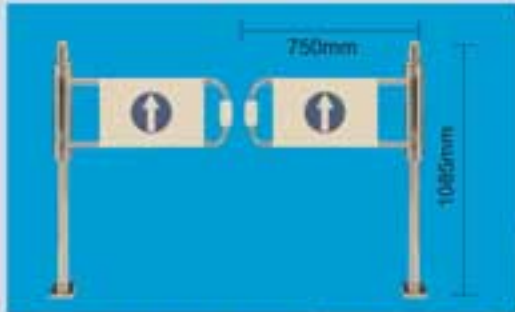

TURNSTILES

TOP TURNING TURNSTILE WITHOUT SIDE GATE

Code: **V013** Clockwise
V014 Anti clockwise



SIDE WINDING TURNSTILE

Code: **V015** Left Hand turnstile
V016 Right Hand turnstile

SIDE WINDING TURNSTILE



V015
V016

TOP TURNING TURNSTILE WITH SIDE GATE

Code: **V017** Clockwise
V018 Anti Clockwise
 (Barrier on left)

TOP TURNING TURNSTILE WITH SIDE GATE

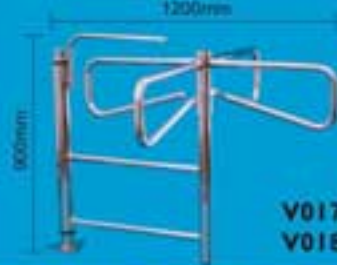

V017
V018

Code: **V019** Turnstile Barrier

available in polished chrome or medium grey

TOP TURNING TURNSTILE WITH BARRIER



TURNSTILE BARRIER



V019

BARRIER RAILS

BARRIERS

UPRIGHT POSTS (STANCHIONS)

Code: **V020** End
V021 Corner
V022 Centre

With black plastic connectors and inserts.



CENTRE



END



CORNER

ROUND TUBING

Code: **V030** 33mm x 2mm (per metre)
V031 33mm x 2mm x 2000mm
V032 33mm x 2mm x 1500mm



Industrial Storage



HEAVY DUTY - MAXIMUM BRACING

TINY RACK SYSTEM

This top quality boltless Tiny Rack System is designed to be a strong and attractive shelving system. The system simply clips together to allow fast and simple installation on site.

Its application includes merchandising heavy stock on the shop floor, cold room storage, office and back store storage.

Wooden decks can also be used with the new stepped beams.



LIGHT DUTY - MINIMUM BRACING

TINY RACK UPRIGHTS

Finish:	Epoxy Blue	
Code:	W020	1800mm
	W021	2100mm
	W022	2400mm



TINY RACK DECKS

Finish:	Light Cream or Ivory	
Code:	W026	1000mm x 450mm
	W027	1000mm x 600mm



TINY RACK SHELVES

Code:	W029	1000mm x 450mm
	W030	1000mm x 600mm

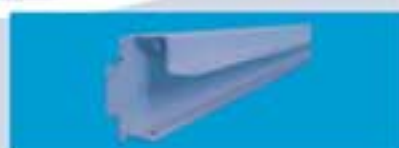

END BRACES

Finish:	Light Cream or Ivory	
Code:	W031	450mm
	W032	600mm
	W033	875mm



BEAMS

Stepped to allow drop in steel or wooden decks

Finish:	Light Cream or Ivory	
Code:	W034	1000mm

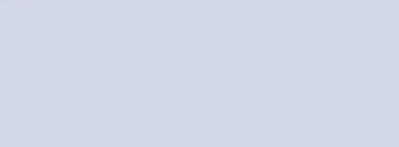

SHELF BRACES

Finish:	Light Cream or Ivory	
Code:	W041	450mm
	W042	600mm
	W043	870mm

Industrial Storage

EZEE ANGLE SHELVING



Ezee Angle Rack is a low cost bolt and nut industrial storage system. Its applications range from storing office files to large double tiered industrial storage warehouses. The dividers, side and back panels allow stock to be divided easily.



Plastic foot:
Code X035

EZEE ANGLE UPRIGHT

38mm x 38mm ANGLE

Finish: Epoxy Ivory or Chrysler Blue

Code: X030	1830mm
X031	2134mm
X032	2438mm
X035	Angle Upright Plastic Foot



EZEE ANGLE SHELF

Finish: Ivory

Code: X045	914mm x 305mm
X046	914mm x 381mm
X047	914mm x 457mm
X048	914mm x 533mm
X049	914mm x 610mm

(1m shelves also available)



CORNER BRACES

Finish: Ivory

Code: X050



BACK AND SIDE PANELS - For Ezee Angle Closed Units

Finish:	Ivory	305mm	381mm	457mm	533mm	610mm	914mm
Code:	1830mm	X061	X064	X067	X070	X073	X076
	2134mmx	X062	X065	X068	X071	X074	X077
	2438mmx	X063	X066	X069	X072	X075	X078

SHELF DIVIDERS - For Ezee Angle Cubicle Units

Finish: Ivory

	Height	Depth		
Code:	305mm	381mm	457mm	533mm
	381mm	X080	X085	X090
	457mm	X081	X086	X091
	533mm	X082	X087	X092
	610mm	X083	X088	X093
		X084	X089	X094

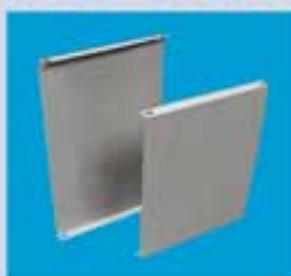

Industrial Storage

STEEL FLOORING



OPEN GRID

STUDDED, WITH RETURN LIP

Code: **Y010** 229mm x 2438mm

Y011 229mm x 1220mm



OPEN GRID

STUDDED, WITH RETURN LIP

Code: **Y015** 152mm x 2438mm

Y016 152mm x 1220mm



SOLID FLOORING

STUDDED, WITH RETURN LIP

Code: **Y030** 152mm x 2438mm

Y035 152mm x 1220mm



CONNECTORS

Code: **Y040**



Industrial Storage

EZEE LOK - Boltless Racking

LIGHT DUTY - Series 25 (2 ton system)

2 ton maximum recommended loading per bay with a minimum of 3 beam levels

TINY RACK FRAMES - Welded

Height	Width	
	610mm	914mm
1800mm	Z010	Z013
2100mm	Z011	Z014
2400mm	Z012	Z015



TINY RACK BOX BEAMS

Max spread loading per pair of beams
Beam Height

Beam Length	Code	50mm		Code	75mm	
		Code	Weight		Code	Weight
1200mm	Z016	Z016	696kg/pair	Z021	1062kg/pair	
1500mm	Z017	Z017	557kg/pair	Z022	-	
1800mm	Z018	Z018	419kg/pair	Z023	723kg/pair	
2100mm	Z019	Z019	308kg/pair	Z024	535kg/pair	
2400mm	Z020	Z020	-	Z025	481kg/pair	

Pic to come

MEDIUM DUTY - Series 35 (4 ton system)

4 ton maximum recommended loading per bay with a minimum of 3 beam levels

WELDED FRAMES

Height	Width		
	762mm	914mm	1220mm
1830mm	Z305	Z306	Z307
2400mm	Z315	Z316	Z317
2700mm	Z325	Z326	Z327
3000mm	Z335	Z336	Z337

BEAMS

Max spread loading per pair of beams
Beam Height

Beam Length	Code	75mm		Code	100mm	
		Code	Weight		Code	Weight
1200mm Sigma	Z405	Z405	1372kg/pair	Z406	2115kg/pair	
1830mm Sigma	Z415	Z415	823kg/pair	Z416	1358kg/pair	
2430mm Sigma	Z425	Z425	876kg/pair	Z426	1351kg/pair	
2740mm Box	Z435	Z435	771kg/pair	Z436	1188kg/pair	
3000mm Box	Z445	Z445	759kg/pair	Z446	1169kg/pair	



Pic to come



SIGMA BEAM

Galvanized cold room racking made to order

Industrial Storage

EZEE LOK - Boltless Racking

HEAVY DUTY - Series 55 (8 ton system)

8 ton maximum recommended loading per bay with a minimum of 3 beam levels

EZEE LOK FRAMES (Boltless)

Bolted frames also available

Height	Width			
	762mm	914mm	1220mm	1500mm
2166mm	Z505	Z506	Z507	Z508
2470mm	Z515	Z516	Z517	Z518
2775mm	Z525	Z526	Z527	Z528
3000mm	Z535	Z536	Z537	Z538
3610mm	Z545	Z546	Z547	Z548
3990mm	Z555	Z556	Z557	Z558
4518mm	Z565	Z566	Z567	Z568
5100mm	Z575	Z576	Z577	Z578



EZEE LOK FRAMES (Bolted)

Height	Width		
	762mm	914mm	1220mm
2166mm	Z705	Z706	Z707
2470mm	Z715	Z716	Z717
2775mm	Z725	Z726	Z727
3000mm	Z735	Z736	Z737
3610mm	Z745	Z746	Z747
3990mm	Z755	Z756	Z757

EZEE LOK BOX BEAMS

Max spread loading per pair of beams
Beam Height

Beam Length	A		B		C		D		E	
	76mm		100mm		114mm		127mm		140mm	
1830mm	Z605	1676kg/pair	Z606	2651kg/pair	Z607	3194kg/pair	Z680	4273kg/pair	Z609	-
2134mm	Z615	1591kg/pair	Z616	2585kg/pair	Z617	3077kg/pair	Z618	4445kg/pair	Z619	4093kg/pair
2430mm	Z625	1251kg/pair	Z626	2513kg/pair	Z627	3244kg/pair	Z628	3320kg/pair	Z629	4093kg/pair
2740mm	Z635	1107kg/pair	Z636	2140kg/pair	Z637	2359kg/pair	Z638	3256kg/pair	Z639	3273kg/pair
3000mm	Z645	1015kg/pair	Z646	1906kg/pair	Z647	2115kg/pair	Z648	2909kg/pair	Z649	2509kg/pair



Industrial Storage

Industrial Racking

POLYPALL - Bolted Frame (Heavy Duty - 8 ton)

8 ton maximum recommended loading per bay with a minimum of 3 beam levels

FRAMES - Bolted

Code	Height		Width			
			A	B	C	D
Z100	2100mm	x	600mm	900mm	1200mm	1500mm
Z101	2400mm	x	600mm	900mm	1200mm	1500mm
Z102	2700mm	x	600mm	900mm	1200mm	1500mm
Z103	3000mm	x	600mm	900mm	1200mm	1500mm
Z104	3600mm	x	600mm	900mm	1200mm	1500mm
Z105	4200mm	x	600mm	900mm	1200mm	1500mm

These frames are supplied in component form, for ease of transport and storage, to be assembled on site.

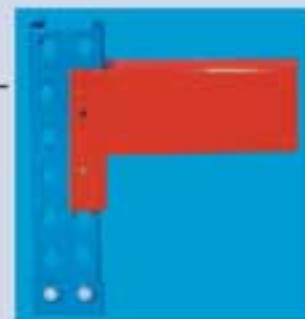

BOX BEAMS

Max spread loading per pair of beams
Beam Height

Code	Beam length	A	B	C	D	E
		76mm	100mm	114mm	127mm	140mm
Z060	1830mm	1676kg/pair	2651kg/pair	3000kg/pair	3389kg/pair	-
Z061	2134mm	1591kg/pair	2585kg/pair	2620kg/pair	3000kg/pair	4093kg/pair
Z062	2430mm	1251kg/pair	2513kg/pair	2301kg/pair	2688kg/pair	4093kg/pair
Z063	2740mm	1107kg/pair	2140kg/pair	2041kg/pair	2384kg/pair	3273kg/pair
Z064	3000mm	1015kg/pair	1906kg/pair	1864kg/pair	2177kg/pair	2509kg/pair



LINK 51 - Racking System

available on request

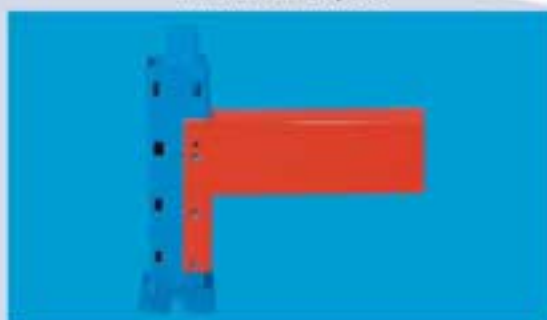

LOUVRE Racking System

available on request



Industrial Storage

INDUSTRIAL RACKING

ROW CONNECTOR

Finish:	Epoxy Ivory or White	
Code:	Z200	300mm
	Z201	400mm
	Z202	500mm



DECK SUPPORTS

Finish:	Epoxy Ivory or White	
Code:	Z210	914mm light duty
	Z211	914mm heavy duty
	Z212	1220mm heavy duty



STEEL DECK

Finish:	Epoxy Ivory or White	
Code:	Z220	450mm x 914mm 1.6mm
	Z221	910mm x 914mm 2mm
	Z222	1210mm x 914mm 2mm
	Z223	1800mm x 610mm 2mm



TIMBER DECK

Finish:	Wood	
Code:	Z230	910mm x 900mm (or 600mm)
	Z231	1200mm x 900mm (or 600mm)
	Z232	1200mm x 900mm (or 600mm)
	Z233	1820mm x 900mm (or 600mm)



LOCKING PIN

Finish:	Bright Galvanised	
Code:	Z240	



Z-BRACKET

Finish:	Epoxy, Ivory or White	
Code:	Z250	300mm



DISPLAY PLATFORM

Finish:	Epoxy, Ivory or White	
Code:	Z260	1000mm x 1000mm
	Z261	1000mm x 600mm
	Z262	1000mm x 1200mm



STEP 7

STRAIGHTENING PROCEDURE

STEP 1

a) TURN UPRIGHTS "1" AND "2" LEVELLING SCREWS OUT BY APPROXIMATELY 25-35mm. PULL A FISH LINE OR STRING FROM UPRIGHT "1" TO "2" (WHERE THE BASE FOOT TOUCHES THE UPRIGHT). THEN TURN THE #BETWEEN UPRIGHTS (2 AND 3) LEVELLING SCREWS EITHER UP OR DOWN UNTIL THE BASE FEET ALL LINE UP WITH THE FISH LINE.

b) ALWAYS ENSURE THAT AT LEAST 25mm OF THE LEVELLING SCREW IS INSIDE THE NYLON INSERT AND GENERALLY ATTEMPT TO TURN ALL LEVELLERS IN AS FAR AS POSSIBLE.

c) LONGER LEVELLING SCREWS ARE AVAILABLE FOR VERY UNEVEN FLOORS.

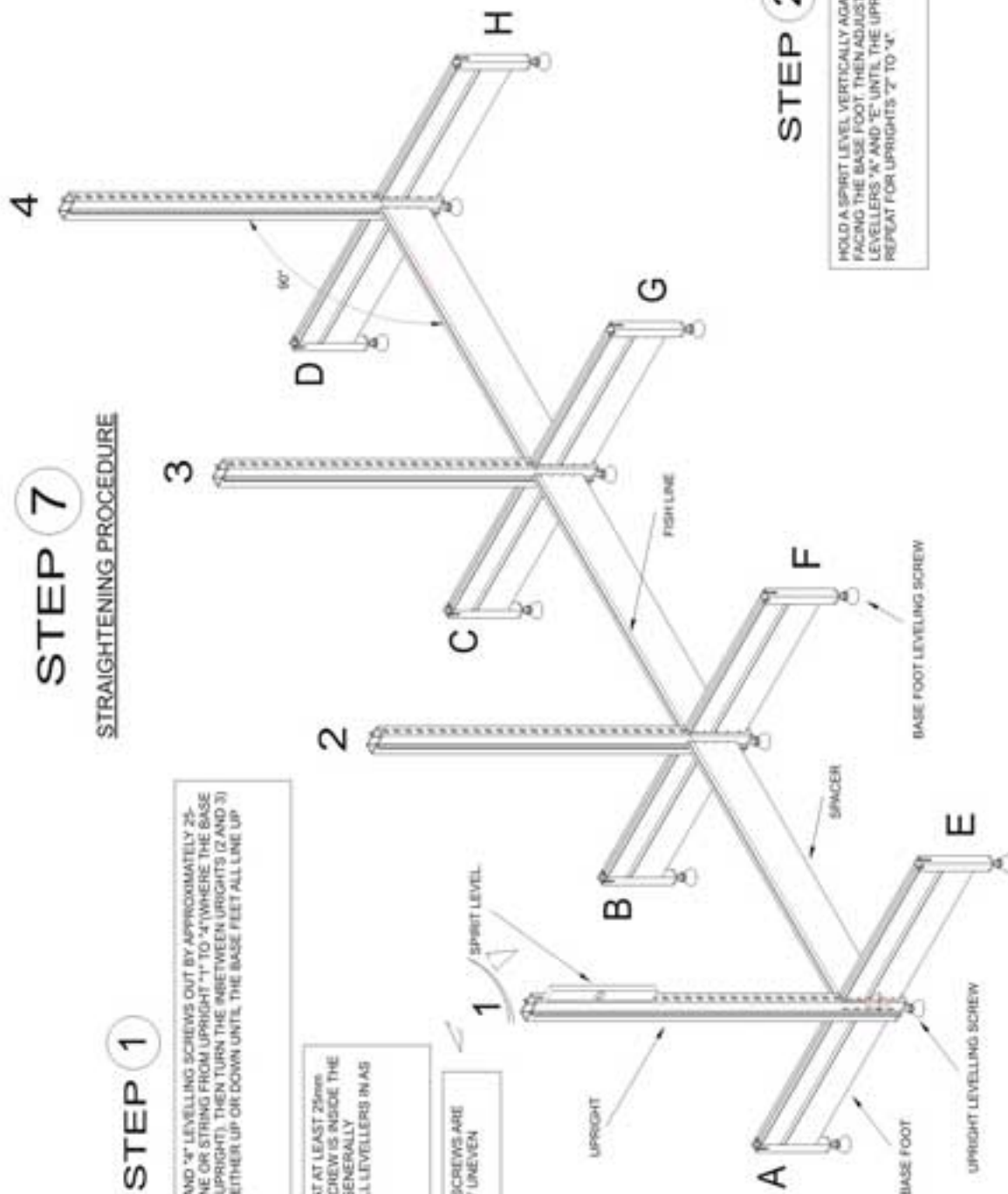

STEP 2

HOLD A SPIRIT LEVEL VERTICALLY AGAINST UPRIGHT "1", FACING THE BASE FOOT. THEN ADJUST BASE FEET LEVELLERS "A" AND "C" UNTIL THE UPRIGHT IS VERTICAL. REPEAT FOR UPRIGHTS "2" TO "3".

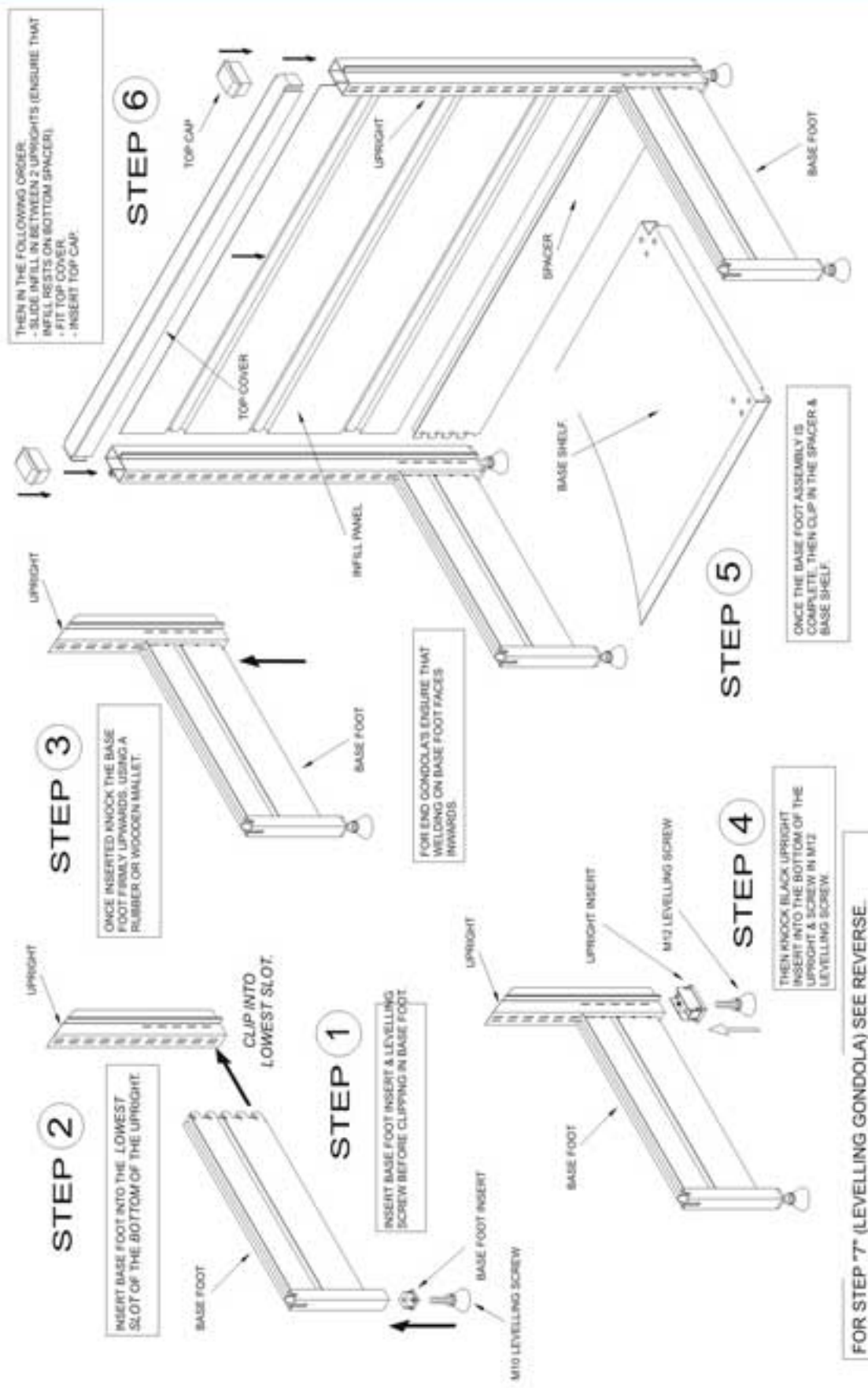

Installation Service

Column extension



914 Gondola System



914 Gondola System



1220 Gondola System

